

DIGITAL MONITOR SPEAKERS MS20/MS40

User's Manual

GB

Version 1.1 August 2005



www.behringer.com



DIGITAL MONITOR SPEAKERS MS20/MS40

IMPORTANT SAFETY INSTRUCTIONS



CAUTION: To reduce the risk of electric shock, do not remove the top cover (or the rear section). No user serviceable parts inside; refer servicing to qualified personnel.

WARNING: To reduce the risk of fire or electric shock, do not expose this appliance to rain and moisture. The apparatus shall not be exposed to dripping or splashing and no objects filled with liquids, such as vases, shall be placed on the apparatus.



This symbol, wherever it appears, alerts you to the presence of uninsulated dangerous voltage inside the enclosure—voltage that may be sufficient to constitute a risk of shock.



This symbol, wherever it appears, alerts you to important operating and maintenance instructions in the accompanying literature. Please read the manual.

WARNING
THIS EQUIPMENT IS CAPABLE OF DELIVERING SOUND PRESSURE LEVELS IN EXCESS OF 90 dB, WHICH MAY CAUSE PERMANENT HEARING DAMAGE.

DETAILED SAFETY INSTRUCTIONS:

- 1) Read these instructions.
 - 2) Keep these instructions.
 - 3) Heed all warnings.
 - 4) Follow all instructions.
 - 5) Do not use this apparatus near water.
 - 6) Clean only with dry cloth.
 - 7) Do not block any ventilation openings. Install in accordance with the manufacturer's instructions.
 - 8) Do not install near any heat sources such as radiators, heat registers, stoves, or other apparatus (including amplifiers) that produce heat.
 - 9) Do not defeat the safety purpose of the polarized or grounding-type plug. A polarized plug has two blades with one wider than the other. A grounding type plug has two blades and a third grounding prong. The wide blade or the third prong are provided for your safety. If the provided plug does not fit into your outlet, consult an electrician for replacement of the obsolete outlet.
 - 10) Protect the power cord from being walked on or pinched particularly at plugs, convenience receptacles, and the point where they exit from the apparatus.
 - 11) Only use attachments/accessories specified by the manufacturer.
 - 12) Use only with the cart, stand, tripod, bracket, or table specified by the manufacturer, or sold with the apparatus. When a cart is used, use caution when moving the cart/apparatus combination to avoid injury from tipping over.
- 
- 13) Unplug this apparatus during lightning storms or when unused for long periods of time.
- 14) Refer all servicing to qualified service personnel. Servicing is required when the apparatus has been damaged in any way, such as power supply cord or plug is damaged, liquid has been spilled or objects have fallen into the apparatus, the apparatus has been exposed to rain or moisture, does not operate normally, or has been dropped.
- 15) CAUTION - These service instructions are for use by qualified service personnel only. To reduce the risk of electric shock do not perform any servicing other than that contained in the operation instructions unless you are qualified to do so.

FOREWORD



Dear Customer,
welcome to the team of BEHRINGER users, and thank you very much for expressing your confidence in us by purchasing this studio monitor.

Writing this foreword for you gives me great pleasure, because it represents the culmination of many months of hard work delivered by our engineering team to achieve a very ambitious goal: to present a pair of outstanding digital monitor speakers, whose excellent sound

and vast connection options makes them ideal for use in every computer studio. The task of designing our new DIGITAL MONITOR SPEAKERS certainly meant a great deal of responsibility, which we assumed by focusing on you, the discerning user and musician. Meeting your expectations also meant a lot of work and night shifts. But it was fun, too. Developing a product usually brings a lot of people together, and what a great feeling it is when all who participated in such a project can be proud of what they've achieved.

It is our philosophy to share our enjoyment with you, because you are the most important member of the BEHRINGER team. With your highly competent suggestions for new products you've made a significant contribution to shaping our company and making it successful. In return, we guarantee you uncompromising quality as well as excellent technical and audio properties at an extremely reasonable price. All of this will enable you to give free rein to your creativity without being hampered by budget constraints.

We are often asked how we manage to produce such high-quality devices at such unbelievably low prices. The answer is quite simple: it's you, our customers! Many satisfied customers mean large sales volumes enabling us to get better purchasing terms for components, etc. Isn't it only fair to pass this benefit on to you? Because we know that your success is our success too!

I would like to thank all of you who have made the MS20 and MS40 possible. You have all made your own personal contributions, from the developers to the many other employees at this company, and to you, the BEHRINGER user.

My friends, it's been worth the effort!

Thank you very much,

Uli Behringer

1. INTRODUCTION

Thank you very much for expressing your confidence in us by purchasing the BEHRINGER DIGITAL MONITOR SPEAKERS MS20/MS40. The MS20/MS40 are active loudspeakers that reproduce your music with highest fidelity and balance. Due to their flexible connection options, the MS20/MS40 can be used in a variety of applications, such as computer studios and audio or multimedia workstations. You can also use them to monitor your keyboards and playback.

Two digital inputs plus two stereo analog inputs enable you to connect a broad range of sound sources and mix two of them within the loudspeakers. Additionally, we have equipped the MS20/MS40 with a headphone connector. The speakers are magnetically shielded, so you can use them near computer monitors.

 **This User's Manual is intended to familiarize you with the unit's control elements, so that you can master all the functions. After having thoroughly read the user's manual, store it at a safe place for future reference.**

1.1 Before getting started

1.1.1 Shipment

Your MS20/MS40 speakers were carefully packed at the assembly plant to assure secure transport. If the cardboard box is damaged, please inspect the equipment immediately for any signs of physical damage.

 **NEVER send damaged units directly to BEHRINGER. Please, immediately notify the dealer from whom you acquired the unit and the transportation company that delivered the unit to you. Otherwise, all claims for replacement/repair may be rendered invalid.**

 **We recommend that you always use an appropriate carrying case when transporting your MS20/MS40 speakers to ensure their optimal protection.**

 **Always use the original packaging to avoid damage when shipping or storing the unit.**

 **Never let unsupervised children play with the MS20/MS40 or with its packaging.**

 **Please dispose of all packaging materials in an environmentally-friendly fashion.**

1.1.2 Initial operation

Please make sure the unit is provided with sufficient ventilation, and never place the MS20/MS40 on top of an amplifier or in the vicinity of a heater to avoid the risk of overheating.

 **Before plugging the unit into a power socket, please make sure that the voltage corresponds to the voltage stated on the label on the backside of your MS20/MS40.**

Power is delivered via the cable enclosed with the unit. All required safety precautions have been adhered to.

ATTENTION!

 **These monitor speakers are capable of producing extreme volumes. Please bear in mind that high sound pressures do not only temporarily damage your sense of hearing, they can also cause permanent damage. Be sure to select an appropriate volume level.**

DIGITAL MONITOR SPEAKERS MS20/MS40

1.1.3 Online registration

Please, do remember to register your new BEHRINGER equipment right after your purchase by visiting www.behringer.com (or www.behringer.de) and kindly read the terms and conditions of our warranty carefully.

Should your BEHRINGER product malfunction, our goal is to have it repaired as quickly as possible. To arrange for warranty service, please contact the retailer from whom the equipment was purchased. Should your BEHRINGER dealer not be located in your vicinity, you may directly contact one of our subsidiaries. Corresponding contact information is included in the original equipment packaging (Global Contact Information/European Contact Information). Should your country not be listed, please contact the distributor nearest you. A list of distributors can be found in the support area of our website (www.behringer.com).

Registering your purchase and equipment with us helps us process your repair claims quicker and more efficiently.

Thank you for your cooperation!

2. CONTROL ELEMENTS AND CONNECTIONS

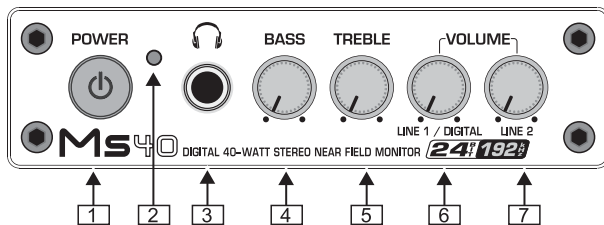

Fig. 2.1: Front panel elements (right loudspeaker)

1 Use the **POWER** switch to power up your MS20/MS40. The **POWER** switch should always be in the "Off" position when you are about to connect your unit to the mains.

Please note: The POWER switch does not fully disconnect the unit from the mains. To disconnect the unit from the mains, pull out the main cord plug or appliance coupler. Unplug the power cord when the unit is not used for prolonged periods of time.

Monitor speakers should be the last device in the signal chain to be switched on and the first to be switched off. This way, you avoid speaker damage caused by loud crackling noises during turning other equipment in your studio on or off.

2 This LED lights up when power is switched on.

3 Connect your headphones via the phones output (1/4" TRS) to monitor any of the input devices. The internal speakers are automatically muted when headphones are connected to the unit.

4 **BASS** control. Turn the bass control to adjust the bass level.

5 **TREBLE** control. Turn the treble control to adjust the treble level.

Turn the **VOLUME** controls 6 and 7 to adjust the overall volume levels of the devices connected to your MS20/MS40:

6 The **LINE 1 / DIGITAL** knob controls the volume level of the analog **LINE 1** 12 or the **DIGITAL** inputs 8 or 9.

7 Turn **LINE 2** control to adjust the volume level of **LINE 2** input 13.

Attention: High volume levels may damage your hearing and/or your headphones. Please turn the VOLUME controls all the way to the left before powering up the unit. Be sure to always select an appropriate volume level.

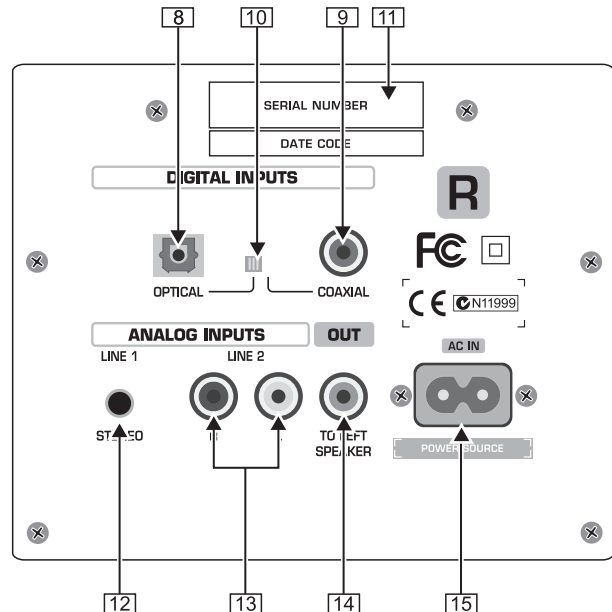

Fig. 2.2: Rear panel (right monitor)

8 Digital audio data can be fed in at the **OPTICAL** input.

9 The MS40 also features a digital **COAXIAL** input connector.

10 With this switch you can select the digital input (**OPTICAL** or **COAXIAL**).

11 **SERIAL NUMBER**.

12 Analog input **LINE 1** (1/8" TRS) allows you to connect stereo audio equipment such as CD/MD players.

13 Use the analog input **LINE 2** (RCA) to connect your sound card, keyboard or expander.

You can play back various signals by using both stereo inputs simultaneously.

14 **TO LEFT SPEAKER** output connector. Connect both speakers by using the speaker cable included in this package. As soon as both speakers are properly connected, they will function as a stereo speaker system.

15 A standard power socket is provided for connection to the mains. A matching power cable is included with the unit. Before you connect the unit to the power source make sure that the power switch is turned off and the volume controls are turned all the way to the left to avoid any damage to speakers or other devices.

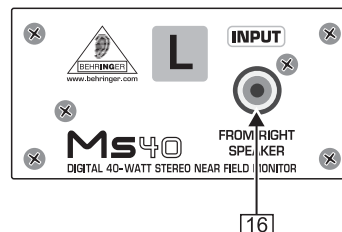

Fig. 2.3: Rear panel (left monitor)

16 **FROM RIGHT SPEAKER** connector. Insert the speaker cable from the **TO LEFT SPEAKER** connector.

DIGITAL MONITOR SPEAKERS MS20/MS40

3. WIRING

The DIGITAL MONITOR SPEAKERS MS20/MS40 are designed to accommodate a variety of connector types for almost any situation you may encounter.

You will find all audio inputs on the right speaker. The left speaker only has one audio input which is fed from the right speaker.

 **Be sure to mute the signal sources before you put the monitor speakers into operation.**

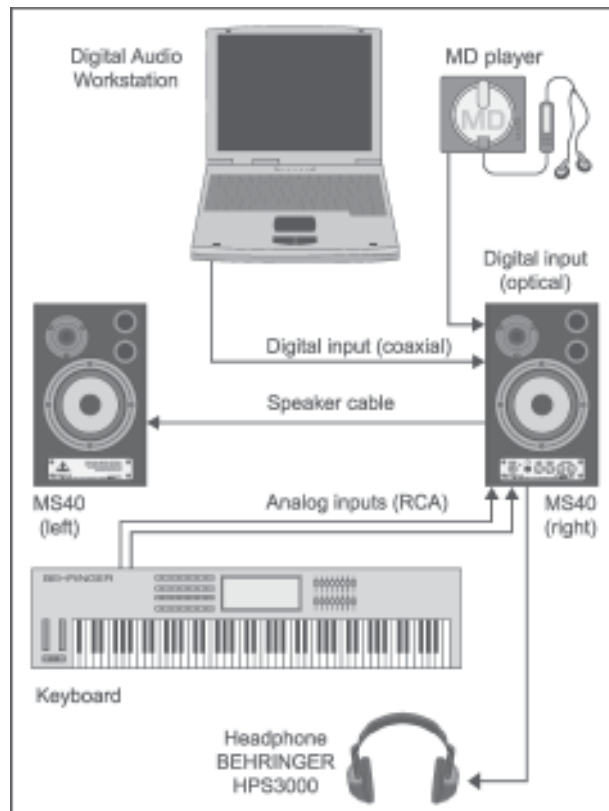

Fig. 3.1: Computer/keyboard setup

Begin by connecting the left speaker to the right speaker by wiring the attached speaker cable from connector [14] to connector [16] on the left speaker.

Connect the analog outputs of your mixer, keyboard or computer sound card to *LINE 1* input [12]. Connect a second piece of equipment to *LINE 2* inputs [13].

If you own equipment with digital connectors—such as CD or MD players—simply connect them to the digital inputs [8] and [9]. Select the digital signal you want to monitor with the input selector switch [10].

You can mix two input signals within the MS20/MS40 by using the volume controls [6] and [7]. This enables you to monitor two different sound sources simultaneously. The above wiring example shows how you can monitor your live keyboard performance to a playback coming from your MD player or digital audio workstation (computer).

The MS20/MS40 speakers are shielded, which allows you to place them near your computer monitor without causing interference or damage. However, do not place your MS20/MS40 speakers near power amps. Doing so will result in an induced hum in your speakers.

4. SPECIFICATIONS

Loudspeakers

MS20:
Tweeter Ø 65 mm (2 1/2"), 8 Ω
Woofer Ø 92 mm (3 5/8"), 4 Ω

MS40:
Tweeter Ø 65 mm (2 1/2"), 8 Ω
Woofer Ø 120 mm (4 3/4"), 4 Ω

Audio inputs

Line 1 1/8" TRS stereo, impedance 20 kΩ
Line 2 2 RCA, impedance 20 kΩ

Digital inputs

Optical TOSLINK
Coaxial RCA
Converter 24-bit
Sample rate ≤ 192 kHz

System specifications

MS20:
Output power 2 x 10 W
Frequency response 65 Hz to 25 kHz

MS40:
Output power 2 x 20 W
Frequency response 50 Hz to 25 kHz

Power supply

Mains voltages USA/Canada 120 V~, 60 Hz
Europe/U.K./Australia 230 V~, 50 Hz
China 220 V~, 50 Hz
Japan 100 V~, 50 - 60 Hz
General export model 120/230 V~, 50 - 60 Hz

Power consumption

MS20: 80 W
MS40: 90 W

Physical

MS20:
Dimensions (H x W x D) 9 2/5" x 6" x 7 3/8"
239 mm x 154 mm x 187 mm
Weight right: 8.14 lbs. (3.7 kg)
left: 4.51 lbs. (2.05 kg)

MS40:
Dimensions (H x W x D) 11" x 6 4/5" x 9 5/8"
279 mm x 173 mm x 245 mm
Weight right: 10.78 lbs. (4.9 kg)
left: 7.04 lbs. (3.2 kg)

BEHRINGER is constantly striving to maintain the highest professional standards. As a result of these efforts, modifications may be made from time to time to existing products without prior notice. Specifications and appearance may differ from those listed or illustrated.

5. WARRANTY

§ 1 OTHER WARRANTY RIGHTS AND NATIONAL LAW

1. This warranty does not exclude or limit the buyer's statutory rights provided by national law, in particular, any such rights against the seller that arise from a legally effective purchase contract.

2. The warranty regulations mentioned herein are applicable unless they constitute an infringement of national warranty law.

§ 2 ONLINE REGISTRATION

Please do remember to register your new BEHRINGER equipment right after your purchase by visiting www.behringer.com (alternatively www.behringer.de) and kindly read the terms and conditions of our warranty carefully. Registering your purchase and equipment with us helps us process your repair claims quicker and more efficiently. Thank you for your cooperation!

§ 3 WARRANTY

1. BEHRINGER (BEHRINGER International GmbH including all BEHRINGER subsidiaries listed on the enclosed page, except BEHRINGER Japan) warrants the mechanical and electronic components of this product to be free of defects in material and workmanship for a period of one (1) year* from the original date of purchase, in accordance with the warranty regulations described below. If the product shows any defects within the specified warranty period that are not excluded from this warranty as described under § 5, BEHRINGER shall, at its discretion, either replace or repair the product using suitable new or reconditioned parts. In the case that other parts are used which constitute an improvement, BEHRINGER may, at its discretion, charge the customer for the additional cost of these parts.

2. If the warranty claim proves to be justified, the product will be returned to the user freight prepaid.

3. Warranty claims other than those indicated above are expressly excluded.

§ 4 RETURN AUTHORIZATION NUMBER

1. To obtain warranty service, the buyer (or his authorized dealer) must call BEHRINGER (see enclosed list) during normal business hours **BEFORE** returning the product. All inquiries must be accompanied by a description of the problem. BEHRINGER will then issue a return authorization number.

2. Subsequently, the product must be returned in its original shipping carton, together with the return authorization number to the address indicated by BEHRINGER.

3. Shipments without freight prepaid will not be accepted.

§ 5 WARRANTY REGULATIONS

1. Warranty services will be furnished only if the product is accompanied by a copy of the original retail dealer's invoice. Any product deemed eligible for repair or replacement under the terms of this warranty will be repaired or replaced.

2. If the product needs to be modified or adapted in order to comply with applicable technical or safety standards on a national or local level, in any country which is not the country for which the product was originally developed and manufactured, this modification/adaptation shall not be considered a defect in materials or workmanship. The warranty does not cover any such modification/adaptation, irrespective of whether it was carried out properly or not. Under the terms of this warranty, BEHRINGER shall not be held responsible for any cost resulting from such a modification/adaptation.

3. Free inspections and maintenance/repair work are expressly excluded from this warranty, in particular, if caused by improper handling of the product by the user. This also applies to defects caused by normal wear and tear, in particular, of faders, crossfaders, potentiometers, keys/buttons, tubes, guitar strings, illuminants and similar parts.

4. Damages/defects caused by the following conditions are not covered by this warranty:

- ▲ improper handling, neglect or failure to operate the unit in compliance with the instructions given in BEHRINGER user or service manuals.
- ▲ connection or operation of the unit in any way that does not comply with the technical or safety regulations applicable in the country where the product is used.
- ▲ damages/defects caused by force majeure or any other condition that is beyond the control of BEHRINGER.

5. Any repair or opening of the unit carried out by unauthorized personnel (user included) will void the warranty.

6. If an inspection of the product by BEHRINGER shows that the defect in question is not covered by the warranty, the inspection costs are payable by the customer.

7. Products which do not meet the terms of this warranty will be repaired exclusively at the buyer's expense. BEHRINGER will inform the buyer of any such circumstance. If the buyer fails to submit a written repair order within 6 weeks after notification, BEHRINGER will return the unit C.O.D. with a separate invoice for freight and packing. Such costs will also be invoiced separately when the buyer has sent in a written repair order.

§ 6 WARRANTY TRANSFERABILITY

This warranty is extended exclusively to the original buyer (customer of retail dealer) and is not transferable to anyone who may subsequently purchase this product. No other person (retail dealer, etc.) shall be entitled to give any warranty promise on behalf of BEHRINGER.

§ 7 CLAIM FOR DAMAGES

Failure of BEHRINGER to provide proper warranty service shall not entitle the buyer to claim (consequential) damages. In no event shall the liability of BEHRINGER exceed the invoiced value of the product.

* Customers in the European Union please contact BEHRINGER Germany Support for further details.

Technical specifications and appearance subject to change without notice. The information contained herein is correct at the time of printing. The names of companies, institutions or publications pictured or mentioned and their respective logos are registered trademarks of their respective owners. Their use neither constitutes a claim of the trademarks by BEHRINGER® nor affiliation of the trademark owners with BEHRINGER®. BEHRINGER® accepts no liability for any loss which may be suffered by any person who relies either wholly or in part upon any description, photograph or statement contained herein. Colours and specification may vary slightly from product. Products are sold through our authorised dealers only. Distributors and dealers are not agents of BEHRINGER® and have absolutely no authority to bind BEHRINGER® by any express or implied undertaking or representation. No part of this manual may be reproduced or transmitted in any form or by any means, electronic or mechanical, including photocopying and recording of any kind, for any purpose, without the express written permission of BEHRINGER Spezielle Studioteknik GmbH. BEHRINGER® is a registered trademark.

ALL RIGHTS RESERVED. © 2005 BEHRINGER Spezielle Studioteknik GmbH,
Hanns-Martin-Schleyer-Str. 36-38, 47877 Willich-Münchheide II, Germany.
Tel. +49 2154 9206 0, Fax +49 2154 9206 4903