



STARVILLE

MH-110 Wash
7x10 LED
moving head

Musikhaus Thomann e.K.

Treppendorf 30

96138 Burgebrach

Deutschland

Telephone: +49 (0) 9546 9223-0

E-mail: info@thomann.de

Internet: www.thomann.de

12.02.2015, ID: 325877 (V2)

Table of contents

1	General notes	5
	1.1 Further information.....	6
	1.2 Notational conventions.....	7
	1.3 Symbols and signal words.....	8
2	Safety instructions	10
3	Features	16
4	Installation	17
5	Starting up	21
6	Connections and operating elements	24
7	Operating	29
	7.1 Starting the device.....	29
	7.2 Main menu.....	31
	7.3 Functions in 9-channel DMX mode.....	38
	7.4 Functions in 14-channel DMX mode.....	39
8	Technical specifications	43

9	Plug and connection assignments.....	44
10	Troubleshooting.....	45
11	Cleaning.....	47
12	Protecting the environment.....	48

1 General notes

This manual contains important instructions for the safe operation of the unit. Read and follow the safety instructions and all other instructions. Keep the manual for future reference. Make sure that it is available to all those using the device. If you sell the unit please make sure that the buyer also receives this manual.

Our products are subject to a process of continuous development. Thus, they are subject to change.

1.1 Further information

On our website (www.thomann.de) you will find lots of further information and details on the following points:

Download	This manual is also available as PDF file for you to download.
Keyword search	Use the search function in the electronic version to find the topics of interest for you quickly.
Online guides	Our online guides provide detailed information on technical basics and terms.
Personal consultation	For personal consultation please contact our technical hotline.
Service	If you have any problems with the device the customer service will gladly assist you.

1.2 Notational conventions

This manual uses the following notational conventions:

Letterings

The letterings for connectors and controls are marked by square brackets and italics.

Examples: *[VOLUME]* control, *[Mono]* button.

Displays

Texts and values displayed on the device are marked by quotation marks and italics.

Examples: *'24ch'*, *'OFF'*.

Cross-references



References to other locations in this manual are identified by an arrow and the specified page number. In the electronic version of the manual, you can click the cross-reference to jump to the specified location.

Example: See ↗ *'Cross-references'* on page 7.

1.3 Symbols and signal words

In this section you will find an overview of the meaning of symbols and signal words that are used in this manual.

Signal word	Meaning
DANGER!	This combination of symbol and signal word indicates an immediate dangerous situation that will result in death or serious injury if it is not avoided.
WARNING!	This combination of symbol and signal word indicates a possible dangerous situation that can result in death or serious injury if it is not avoided.
CAUTION!	This combination of symbol and signal word indicates a possible dangerous situation that can result in minor injury if it is not avoided.
NOTICE!	This combination of symbol and signal word indicates a possible dangerous situation that can result in material and environmental damage if it is not avoided.

Warning signs	Type of danger
 A yellow triangular warning sign with a black border and a black lightning bolt symbol in the center, indicating high voltage.	Warning – high-voltage.
 A yellow triangular warning sign with a black border and a black symbol of a person standing next to a suspended load, indicating a suspended load.	Warning – suspended load.
 A yellow triangular warning sign with a black border and a black exclamation mark in the center, indicating a general danger zone.	Warning – danger zone.

2 Safety instructions

Intended use

This device is intended to be used as moving-head spotlight. Use the device only as described in this user manual. Any other use or use under other operating conditions is considered to be improper and may result in personal injury or property damage. No liability will be assumed for damages resulting from improper use.

This device may be used only by persons with sufficient physical, sensorial, and intellectual abilities and having corresponding knowledge and experience. Other persons may use this device only if they are supervised or instructed by a person who is responsible for their safety.

Safety



DANGER!

Danger for children

Ensure that plastic bags, packaging, etc. are disposed of properly and are not within reach of babies and young children. Choking hazard!

Ensure that children do not detach any small parts (e.g. knobs or the like) from the unit. They could swallow the pieces and choke!

Never let children unattended use electrical devices.



DANGER!

Electric shock caused by high voltages inside

Within the device there are areas where high voltages may be present. Never remove any covers.

There are no user-serviceable parts inside.

Do not use the device if covers, protectors or optical components are missing or damaged.



DANGER!

Electric shock caused by short-circuit

Always use proper ready-made insulated mains cabling (power cord) with a protective contact plug. Do not modify the mains cable or the plug. Failure to do so could result in electric shock/death or fire. If in doubt, seek advice from a registered electrician.



WARNING!

Eye damage caused by high light intensity

Never look directly into the light source.



WARNING!

Risk of epileptic shock

Strobe lighting can trigger seizures in photosensitive epilepsy. Sensitive persons should avoid looking at strobe lights.



WARNING!

Risk of injury by falling off

Make sure that the installation complies with the standards and rules that apply in your country. Always secure the device with a secondary safety attachment, such as a safety cable or a safety chain.

The carrying capacity of the truss or other mounting must be sufficient for the intended number of devices. Note that the movement of the head may additionally stress the load-bearing structures.



CAUTION!

Risk of injury due to movements of the device

The head of the device can move quickly (pan, tilt) and can produce very bright light. This is also valid immediately after you turn on the device, when the device operates in automatic mode or under remote control and when you turn off a DMX controller that is connected to the device. Persons staying near the device could be injured or frightened.

Before you turn on the device and during the operation, always ensure that nobody stays close to the device. If work has to be performed in the area of movement or in the near vicinity of the device, it must remain turned off.



NOTICE!

Risk of fire

Do not cover the device nor any ventilation slots. Do not place the device near any direct heat source. Keep the device away from naked flames.



NOTICE!

Operating conditions

This device has been designed for indoor use only. To prevent damage, never expose the device to any liquid or moisture. Avoid direct sunlight, heavy dirt, and strong vibrations.

The device must not be moved while it is in use.



NOTICE!

Power supply

Before connecting the device, ensure that the input voltage (AC outlet) matches the voltage rating of the device and that the AC outlet is protected by a residual current circuit breaker. Failure to do so could result in damage to the device and possibly injure the user.

Unplug the device before electrical storms occur and when it is unused for long periods of time to reduce the risk of electric shock or fire.

3 Features

The moving head is particularly suitable for professional lighting tasks, for example at events, on rock stages, in theatres and musicals or in discotheques.

Special features of the device:

- 7 four-colour LEDs (RGBW, 10 W each)
- Control via DMX (9 or 14 channels) and via buttons and display on the unit
- Preprogrammed automatic show programmes
- Sound control
- Master / Slave mode
- Strobe effect
- Electronic dimmer
- Robust housing with two integrated carrying handles
- Omega bracket with 1/4-turn fasteners included in scope of delivery

4 Installation

Unpack and carefully check that there is no transportation damage before using the unit. Keep the equipment packaging. To fully protect the device against vibration, dust and moisture during transportation or storage use the original packaging or your own packaging material suitable for transport or storage, respectively.

Lift the device only at the base. When lifted at the rotatable mounting, the device may be damaged.

You can install the device standing or hanging upside down. When in use, the device must be mounted at a solid surface or clamped to an approved truss.

Work from a stable platform whenever you install or move the device or when you perform any kind of maintenance. Block access under the work area.



WARNING!

Risk of injury caused by falling objects

Make sure that the installation complies with the standards and rules that apply in your country. Always secure the device with a secondary safety attachment, such as a safety cable or a safety chain.



NOTICE!

Risk of overheating

Always ensure sufficient ventilation.

The ambient temperature must always be below 40 °C (104 °F).



NOTICE!

Possible data transmission errors

For error-free operation make use of dedicated DMX cables and do not use ordinary microphone cables.

Never connect the DMX input or output to audio devices such as mixers or amplifiers.

Mounting options

The mounting points for 1/4-turn fasteners at the underside of the device are used to mount omega brackets securely. There, you can fasten adapters such as half couplers, trigger clamps, c-hooks etc. The safety cable must be led through the safety eye at the backside of the device (↪ *Chapter 6 'Connections and operating elements' on page 24*).

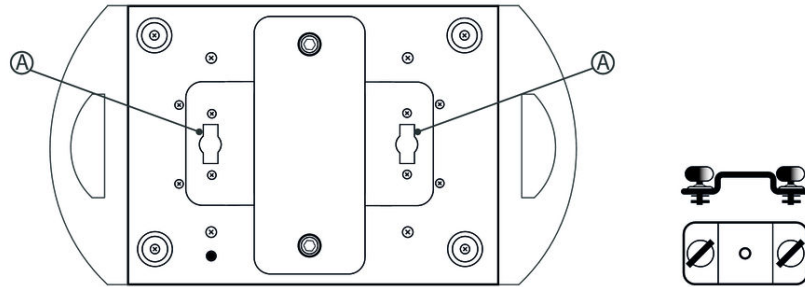

A Mounting points for 1/4-turn fasteners used for omega brackets

5 Starting up

Establish all connections as long as the unit is switched off. Use the shortest possible high-quality cables for all connections.

Connections in DMX mode

Connect the DMX input of the device to the DMX output of a DMX controller or another DMX device. Connect the output of the first DMX device to the input of the second one, and so on to form a daisy chain. Always ensure that the output of the last DMX device in the daisy chain is terminated with a resistor ($110\ \Omega$, $\frac{1}{4}\text{ W}$).

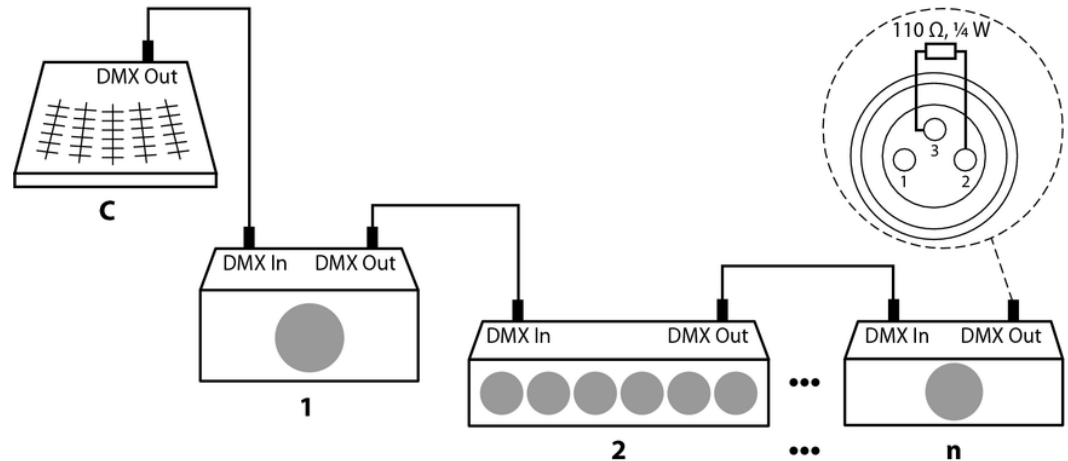

The flashing 'DMX' LED indicates an incoming DMX signal.

Connections in master/slave mode

When you configure a group of devices in master/slave mode, the first unit will control the other units for an automatic, sound-activated, synchronized show. This function is ideal when you want to start a show immediately. Connect the DMX output of the master device to the DMX input of the first slave device. Then connect the DMX output of the first slave device to the DMX input of the second slave device and so on.

6 Connections and operating elements

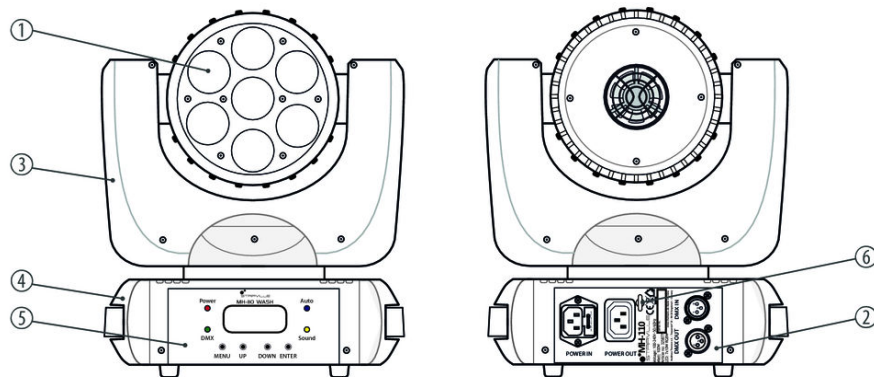

1 Spotlight head with LEDs.

2 Connections.

3	Rotatable mounting.
4	Device base.
5	Operating elements.
6	Safety eye.

Operating elements

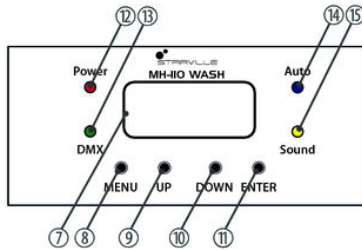

- | | |
|----|---|
| 7 | Display.
When the main menu is activated, the display shows the current menu item and the set option. When the main menu is closed, it shows the current operating mode. The display is dimmed a few seconds after the last keystroke. |
| 8 | <i>[MENU]</i>
Activates the main menu and toggles between menu items. Closes an open sub-menu without saving any changes. |
| 9 | <i>[DOWN]</i>
Decreases the displayed value by one. |
| 10 | <i>[UP]</i>
Increases the displayed value by one. |
| 11 | <i>[ENTER]</i>
Selects an option of the respective operating mode. |
| 12 | <i>[Power]</i>
The LED indicates that the device is connected to the power grid. |

13	<i>[DMX]</i> The LED flashes when a DMX signal is received.
14	<i>[Auto]</i> The LED indicates that the automatic show is running.
15	<i>[Sound]</i> The LED lights up when the music controlled automatic show is running. The briefly flashing LED indicates an incoming signal from the microphone during the music controlled automatic show.

Connections

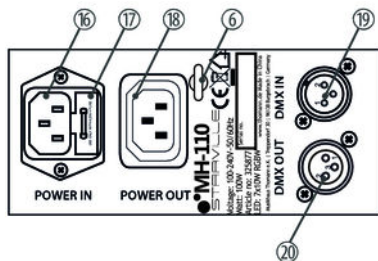

6	Safety eye.
16	<i>[POWER IN]</i> IEC chassis plug for the power supply.
17	Fuse holder. If the fuse blows, replace it with a new fuse of the same type. You must first disconnect the device from the power supply.
18	<i>[POWER OUT]</i> IEC chassis socket for the power supply cable to the next unit.
19	<i>[DMX IN]</i> DMX input.
20	<i>[DMX OUT]</i> DMX output.

7 Operating

7.1 Starting the device



CAUTION!

Risk of injury due to movements of the device

The head of the device can move quickly (pan, tilt) and can produce very bright light. This is also valid immediately after you turn on the device, when the device operates in automatic mode or under remote control and when you turn off a DMX controller that is connected to the device. Persons staying near the device could be injured or frightened.

Before you turn on the device and during the operation, always ensure that nobody stays close to the device. If work has to be performed in the area of movement or in the near vicinity of the device, it must remain turned off.

Connect the device to the power supply to start operation. After a few seconds, the fans start to work, the head moves to the home positions for rotation (pan) and inclination (tilt), the screen displays a start message. After a few more seconds, the device operates in the last set mode.

7.2 Main menu

Press *[MENU]* to activate the main menu. Use the buttons *[UP]* or *[DOWN]* to select a submenu. When the display shows the desired submenu, press *[ENTER]* to open it. To close the main menu, press *[MENU]* or wait for 5 seconds.



As soon as you activate the main menu, the DMX control and a currently running automatic show are being interrupted. The movable head of the unit moves to its home position.

If you close the main menu without making changes, the unit continues to operate with the previous settings.

All previous settings are retained even when you disconnect the device from the mains. To restart with default values, use the function 'System Reset' (↶ 'Default settings' on page 36).

DMX address

Press *[MENU]*, then *[UP]* or *[DOWN]* until the display shows 'DMX Address'. Press *[ENTER]*. The display starts to flash. Now you can set the number of the first DMX channel to be used by the device (DMX address). Use the buttons *[UP]* or *[DOWN]* to select a value between 1 and 512.

When the display shows the desired value, press *[ENTER]* to save the settings and close the submenu. To close the submenu and the main menu without making changes, press *[MENU]* or wait for 5 seconds.

Make sure that the DMX address matches the configuration of your DMX controller. The following table shows the highest possible DMX address for the various DMX modes

Mode	Highest possible DMX address
9-channel	504
14-channel	499

Operating mode 'DMX'

Press *[MENU]*, then *[UP]* or *[DOWN]* until the display shows 'Control Mode'. Press *[ENTER]*. The display starts to flash. With the buttons *[UP]* or *[DOWN]* you can now choose from the following DMX operating modes: 9-channel or 14-channel. This setting is only relevant if the device is controlled via DMX.

When the display shows the desired value, press *[ENTER]* to save the settings and close the submenu. To close the submenu and the main menu without making changes, press *[MENU]* or wait for 5 seconds.

Operating mode 'Master' or 'Slave'

Press *[MENU]*, then *[UP]* or *[DOWN]* until the display shows 'Slave Mode'. Press *[ENTER]*. The display starts to flash. With the buttons *[UP]* or *[DOWN]* you can now select an operating mode:

- 'Slave': The device is controlled by another device, which is configured as master.
- 'Master': The Master device sets the movements and light effects which are copied by the devices configured as Slaves.

When the display shows the desired value, press *[ENTER]* to save the settings and close the submenu. To close the submenu and the main menu without making changes, press *[MENU]* or wait for 5 seconds.

This setting is only relevant if the device is not controlled via DMX.

Automatic show

Press *[MENU]*, then *[UP]* or *[DOWN]* until the display shows 'Auto Sound'. Press *[ENTER]*. The display starts to flash. With the buttons *[UP]* or *[DOWN]* you can now select between 'Auto' (automatic show) and 'Sound' (sound controlled automatic show).

Automatic operation can only be activated when the unit is operating in stand alone mode or as master in a master / slave combination. This setting is only relevant if the device is not controlled via DMX.

Press *[ENTER]* to save the settings and close the submenu. To close the submenu and the main menu without making changes, press *[MENU]* or wait for 5 seconds.

Pan inversion

Press *[MENU]*, then *[UP]* or *[DOWN]* until the display shows 'Pan Inverse'. Press *[ENTER]*. The display starts to flash. With the buttons *[UP]* or *[DOWN]* you can now select between 'No' (normal rotation direction) and 'Yes' (inverted rotation direction).

Press *[ENTER]* to save the settings and close the submenu. To close the submenu and the main menu without making changes, press *[MENU]* or wait for 5 seconds.

Tilt inversion

Press *[MENU]*, then *[UP]* or *[DOWN]* until the display shows *'Tilt Inverse'*. Press *[ENTER]*. The display starts to flash. With the buttons *[UP]* or *[DOWN]* you can now select between *'No'* (normal inclination direction) and *'Yes'* (inverted inclination direction).

When the display shows the desired value, press *[ENTER]* to save the settings and close the submenu. To close the submenu and the main menu without making changes, press *[MENU]* or wait for 5 seconds.

Dimmer speed

With this function you can set how the electronic dimmer operates on changing light conditions.

Press *[MENU]*, then *[UP]* or *[DOWN]* until the display shows *'Dimmer Speed'*. Press *[ENTER]*. The display starts to flash. With the buttons *[UP]* or *[DOWN]* you can now select between *'Fast'* (fast lighting change) and *'Smooth'* (slow lighting changes).

When the display shows the desired value, press *[ENTER]* to save the settings and close the submenu. To close the submenu and the main menu without making changes, press *[MENU]* or wait for 5 seconds.

Operating hours display

Press *[MENU]*, then *[UP]* or *[DOWN]* until the display shows *'Power On Hours'*. Press *[ENTER]*. The display shows how long the device has been already in operation.

To close the operating hours display, press *[ENTER]* or wait for 5 seconds.

Temperature display

Press *[MENU]*, then *[UP]* or *[DOWN]* until the display shows 'Fixture Temp'. Press *[ENTER]*. The display alternately shows the temperature of the LEDs ('LED Temp') and the temperature of the electronics inside the unit ('Main PCB').

To close the temperature display, press *[ENTER]* or wait for 5 seconds.

Selftest

Press *[MENU]*, then *[UP]* or *[DOWN]* until the display shows 'Auto Test'. Press *[ENTER]*. The device now performs a selftest.

To close the selftest, press *[ENTER]* or wait for 5 seconds.

Software version

Press *[MENU]*, then *[UP]* or *[DOWN]* until the display shows 'Firmware Version'. Press *[ENTER]*. The software version of the device will now appear on the display.

To close the software version display, press *[ENTER]* or wait for 5 seconds.

Default settings

With this function, you can reset the device to factory default settings.

Press *[MENU]*, then *[UP]* or *[DOWN]* until the display shows 'System Reset'. Press *[ENTER]*. The device now performs a reset.

Overview

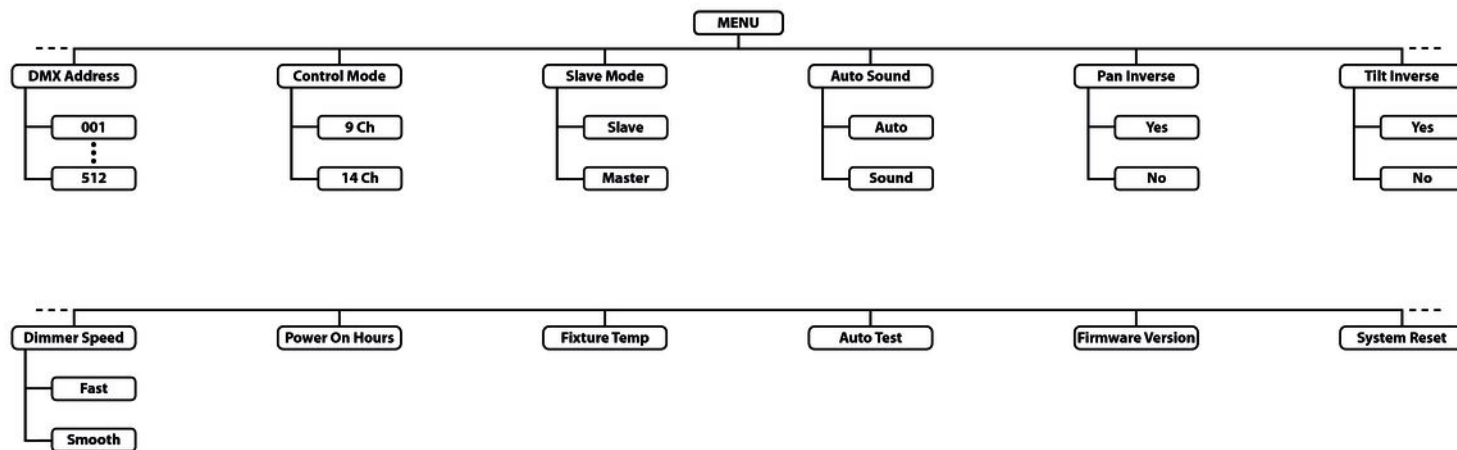

7.3 Functions in 9-channel DMX mode

Channel	Value	Function
1	0...255	Rotation (pan) (0° to 630°)
2	0...255	Inclination (tilt) (0° to 220°)
3	0...255	Speed of rotation (pan) and inclination (tilt), fast to slow
4	0...255	Dimmer (0 % to 100 %)
5	0...255	Intensity Red (0 % to 100 %)
6	0...255	Intensity Green (0 % to 100 %)
7	0...255	Intensity Blue (0 % to 100 %)
8	0...255	Intensity White (0 % to 100 %)
9	Strobe effect	
	0...9	Strobe effect off

Channel	Value	Function
	10...140	Strobe effect, increasing speed
	141...255	Strobe effect, random speed

7.4 Functions in 14-channel DMX mode

Channel	Value	Function
1	0...255	Rotation (pan) (0° to 630°)
2	0...255	Fine adjustment for rotation (pan)
3	0...255	Inclination (tilt) (0° to 220°)
4	0...255	Fine adjustment for inclination (tilt)
5	0...255	Speed of rotation (pan) and inclination (tilt), fast to slow
6	0...255	Dimmer (0 % to 100 %)

Channel	Value	Function
7	0...255	Intensity Red (0 % to 100 %)
8	0...255	Intensity Green (0 % to 100 %)
9	0...255	Intensity Blue (0 % to 100 %)
10	0...255	Intensity White (0 % to 100 %)
11	White with full intensity and adjustable colour temperature	
	0...35	Blackout, all LEDs off
	36...55	Colour temperature 3200 K
	56...75	Colour temperature 3400 K
	76...95	Colour temperature 4200 K
	96...115	Colour temperature 4900 K
	116..135	Colour temperature 5600 K
	136...175	Colour temperature 6500 K
	176...195	Colour temperature 7200 K

Channel	Value	Function
	196...215	Colour temperature 8000 K
	216...235	Colour temperature 8500 K
	236...255	Colour temperature 10000 K
12	Constant colour	
	0...14	Blackout, all LEDs off
	15...255	One of 28 preprogrammed colours
13	Strobe effect	
	0...9	Strobe effect off
	10...140	Strobe effect, increasing speed
	141...255	Strobe effect, random speed
14	Special functions	
	0...99	Without function

Channel	Value	Function
	100...199	Automatic sound controlled show
	200...255	Reset, if the value is transmitted for at least five seconds

8 Technical specifications

Number of DMX channels	9 or 14 channels, depending on operating mode	
Illuminant	7 four-colour LEDs (RGBW, 10 W each)	
Dispersion angle	15°	
Maximum rotation angle (pan)	630°	
Maximum inclination angle (tilt)	220°	
Dimmer	electronic, 0 ... 100 %	
Operating supply voltage	AC 230 V ~ , 50 Hz	
Power consumption	100 W	
Fuse	5 mm × 20 mm, 3.0 A, 250 V, fast-acting	
Dimensions (W × D × H)	260 mm × 148 mm × 310 mm	
Weight	4.5 kg	

9 Plug and connection assignments

Introduction

This chapter will help you select the right cables and plugs to connect your valuable equipment so that a perfect light experience is guaranteed.

Please take our tips, because especially in 'Sound & Light' caution is indicated: Even if a plug fits into a socket, the result of an incorrect connection may be a destroyed DMX controller, a short circuit or 'just' a not working light show!

DMX connections

The unit offers a 3-pin XLR socket for DMX output and a 3-pin XLR plug for DMX input. Please refer to the drawing and table below for the pin assignment of a suitable XLR plug.



Pin	Configuration
1	Ground, shielding
2	Signal inverted (DMX-, 'cold signal')
3	Signal (DMX+, 'hot signal')

10 Troubleshooting



NOTICE!

Possible data transmission errors

For error-free operation make use of dedicated DMX cables and do not use ordinary microphone cables.

Never connect the DMX input or output to audio devices such as mixers or amplifiers.

In the following we list a few common problems that may occur during operation. We give you some suggestions for easy troubleshooting:

Symptom	Remedy
The unit does not work, no light, the fan does not run	Check the mains power connection and the main fuse.
No response to DMX controller	<ol style="list-style-type: none">1. The LED 'DMX' should be flashing on data transmission. If it doesn't, check the DMX connectors and cables for proper connection.2. If the LED 'DMX' lights up without response, check the address settings and DMX polarity.3. Try using another DMX controller.4. Check to see if the DMX cables run near or alongside to high voltage cables that may cause damage or interference to DMX interface circuits.

If the procedures recommended above do not succeed, please contact our Service Center. You can find the contact information at www.thomann.de.

11 Cleaning

Optical lenses

Clean the optical lenses, that are accessible from the outside, regularly in order to optimize the light output. The frequency of cleaning depends on the operating environment: wet, smoky or particularly dirty surroundings can cause more accumulation of dirt on the optics of the device.

- Clean with a soft cloth using our lamp and lens cleaner (item no. 280122).
- Always dry the parts carefully.

Fan grids

The fan grids of the device must be cleaned on a regular basis to remove dust and dirt. Before cleaning, switch off the device and disconnect AC-powered devices from the mains. Use a lint-free damp cloth for cleaning. Never use solvents or alcohol for cleaning.

12 Protecting the environment

Disposal of the packaging material



For the transport and protective packaging, environmentally friendly materials have been chosen that can be supplied to normal recycling.

Ensure that plastic bags, packaging, etc. are properly disposed of.

Do not just dispose of these materials with your normal household waste, but make sure that they are collected for recycling. Please follow the notes and markings on the packaging.

Disposal of your old device



This product is subject to the European Waste Electrical and Electronic Equipment Directive (WEEE). Do not dispose with your normal household waste.

Dispose of this device through an approved waste disposal firm or through your local waste facility. When discarding the device, comply with the rules and regulations that apply in your country. If in doubt, consult your local waste disposal facility.

MH-110 Wash 7x10 LED



